

THE

M-11/NINEmm

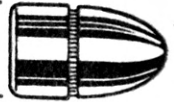

SUBMACHINE GUN

OPERATING MANUAL

No.2



®



**S
W
D, Inc.**

1872 Marietta Blvd., Atlanta, Georgia 30318



M-11/NINEmm 

OPERATION AND MAINTENANCE MANUAL

ALL PHOTO ILLUSTRATIONS AND WORD COMPOSITION ARE PROTECTED BY COPYRIGHT. © JAN. 1990 S.W.D. INC.

COBRAY™

M-11/NINEmm

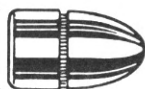

**S
W
D, Inc.**

1872 MARIETTA BLVD./ATLANTA, GEORGIA 30318

TABLE OF CONTENTS

FOREWORD	4
1. INTRODUCTION	4
A. Technical Specifications	5
2. CONSTRUCTION	6
3. OPERATION OF THE WEAPON	6
A. Loading Magazines	6, 7
B. Stock Assembly	7, 8, 9, 10
C. Loading and Cocking the Weapon	10
D. Charging the Weapon	10
E. Inserting the Magazine	11
F. Placing the Weapon on "Safe"	11
G. Removal of Magazine	11, 12
H. Fire Selector Lever Operation	12
I. Firing the Submachine Gun	13
J. Malfunctions	13, 14, 15
4. STRIPPING AND REASSEMBLING	15
A. Field Stripping	15
1) Removing Upper Receiver	15, 16
2) Removing the Bolt	16, 17
3) Removing the Stock	17
B. Trigr Mechanism	18
C. Extractor	18
D. Recoil Spring	18
E. Receiver Pin Catch	18
F. Magazine Catch	18
G. Safety Catch	18
H. Stock Latch	18
I. Magazine	18
5. REASSEMBLY	19
6. CLEANING AND MAINTENANCE	19
7. ILLUSTRATIONS	21, 23, 24
8. PARTS LIST	21, 24

FOREWORD

This manual is published for the information and guidance of personnel whose duties involve the use, maintenance and repair of the M-11/9mm SMG. Disassembly, assembly, cleaning and minor repairs may be undertaken in the field.

In all cases where the nature of the repair or adjustment is beyond the scope of facilities of the unit, the Manufacturer should be informed in order that trained personnel with suitable tools and equipment may be provided.

1. INTRODUCTION

The COBRAY M-11/9mm represents a significant break through in compact submachine gun design. The M-11/9mm is available in 9mm PARA. only.

The weapon is light in weight, durable steel construction and easy to fire, either semi-automatic or full automatic.

The compact size of the M-11/9mm makes it especially suitable for tank crews, gun and mortar crews, etc., and its selective fire capability makes it an excellent weapon for police use.

The addition of a noise suppressor further enhances the performance, reducing the noise and eliminating muzzle flash.

The weapon operates on the straight blowback principle and is magazine fed.

A. TECHNICAL SPECIFICATIONS

COBRAY-M-11/9mm

GUN DIMENSIONS WITHOUT SUPPRESSOR	INCHES
Length without stock	11.25
Length stock telescoped	13.00
Length stock extended	23.00
Barrel length	5.25
Maximum width	1.36

GUN DIMENSIONS WITH SUPPRESSOR ATTACHED	INCHES
Length without stock	22.69
Length stock telescoped	24.44
Length stock extended	34.44
Maximum width	2.13

SUPPRESSOR DIMENSIONS	INCHES
Length	11.44
Diameter	2.13

WEIGHT AND CAPACITY	LBS.
Gun without magazine	3.75
Suppressor	1.20

TYPE OF FIRE Semi-automatic or full automatic.

CYCLIC RATE OF FIRE Minimum 1200 rounds per minute.

MAGAZINE CAPACITY 32 Rounds - 9mm PARA.

FRONT SIGHT Protected post.

REAR SIGHT Fixed aperture for 100 meters.

SAFETY Manually operated safety located on right underside of frame next to trigger.

2. CONSTRUCTION

The weapon consists of the following major components:

Barrel, Receiver, Bolt, Frame, Firing
Mechanism, Magazine, and Extendable Stock

A sling swivel may be attached to the barrel and receiver assembly. The front end of the barrel is threaded to accept a suppressor. The receiver is fitted with a fixed front sight and houses the bolt, recoil spring, buffer and ejector rod. The frame carries the receiver group, trigger mechanism, magazine housing, stock guide, and safety assembly.

The trigger mechanisms consist of sear, sear spring, selector lever, retainer, trip, trigger, trigger pin, trigger spring, and disconnecter.

The stock is designed to telescope into the frame when not in use thereby reducing the overall size of the weapon.

The bolt assembly on the M-11/9mm is fitted with a cocking handle and has a fixed firing pin. The extractor on the M-11/9mm operates on a leaf spring principle and utilizes a compression spring.

The magazine for the M-11/9mm is of the double column single position feed type.

3. OPERATION OF THE WEAPON

A. Loading Magazine

9 MM Para—32 rounds capacity

Hold the magazine in one hand, with the other hand place the magazine loader on top of the magazine, then place the base of the magazine on a firm surface. Push down on the loader to depress the magazine follower. Insert a cartridge, base first, into the magazine. Lift the loader, and push the cartridge all the way into the magazine. Push down on the loader, depressing the cartridge and magazine follower. Repeat the operation (Fig. 1) until the magazine is full, 32 rounds.

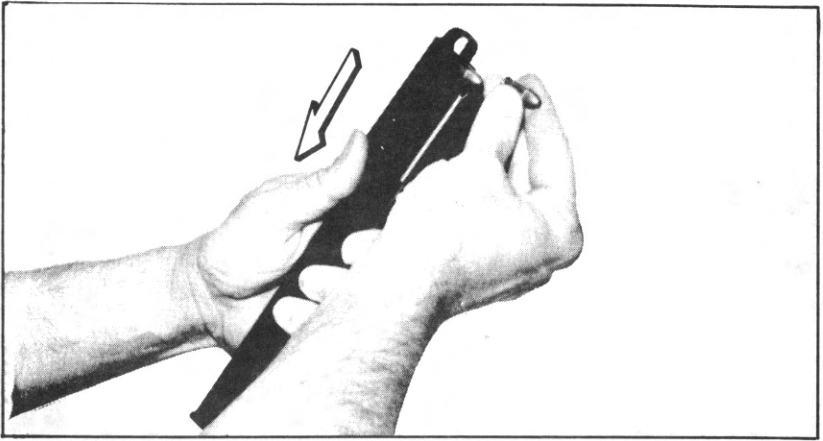

FIG. 1 Pull Down On Loader, Insert Cartridge

B. Stock Assembly

Hold the weapon in the shooting hand, with one finger of the other hand, grasp the top stock extension and pull down until wire form butt locks into place. (See Fig. 2, 3, 4)

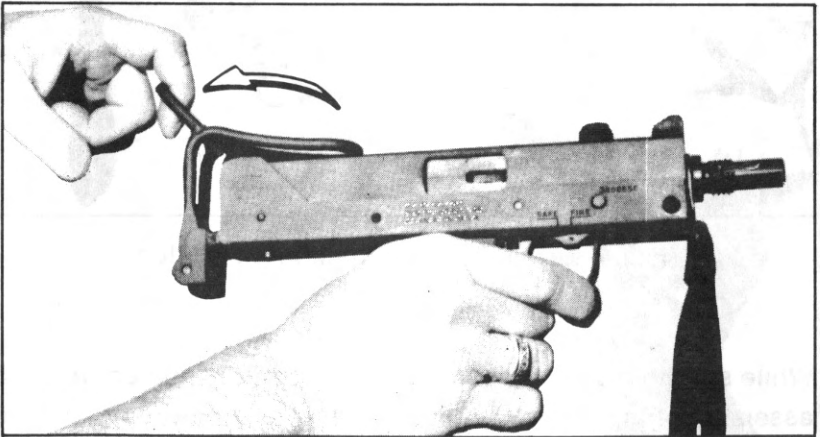

FIG. 2 Place Finger In Wire Form Extension

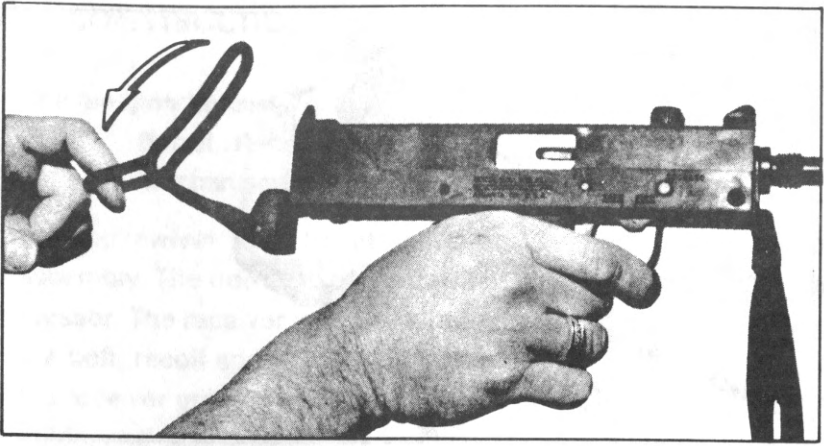

FIG. 3 Pull Down On Wire Form Butt



FIG. 4 Wire Form Butt Lock Into Position

While still holding the weapon in this position, pull entire stock assembly straight back until stock rails lock into normal firing position. (See Fig. 5) This entire operation can be accomplished in one continuous movement.

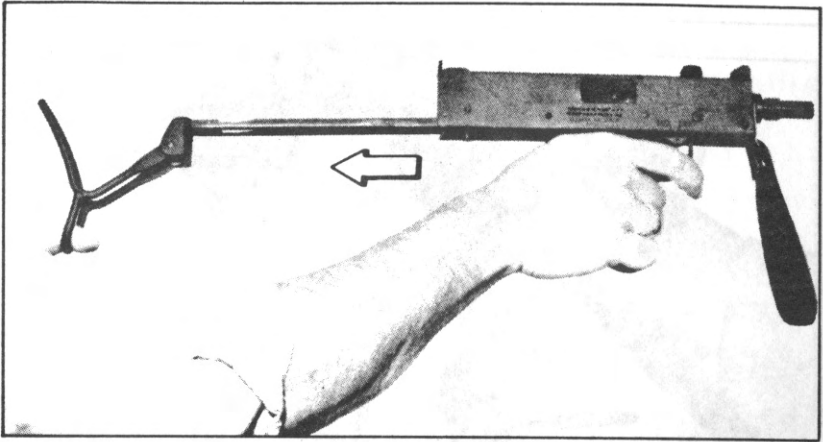

FIG. 5

Retracting Stock Assembly

Hold weapon in one hand, depress stock latch button and with the other hand push stock assembly back into the weapon. (See Fig. 6)

Still holding the weapon, press inwards on right side of wire form butt near the pivot to allow wire form butt to be rotated into closed position. (See Fig. 7)

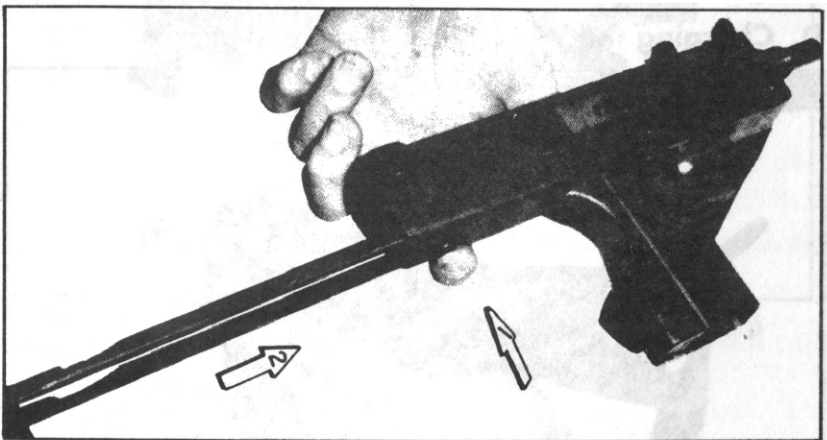

FIG. 6 Retract Wire Form Stock

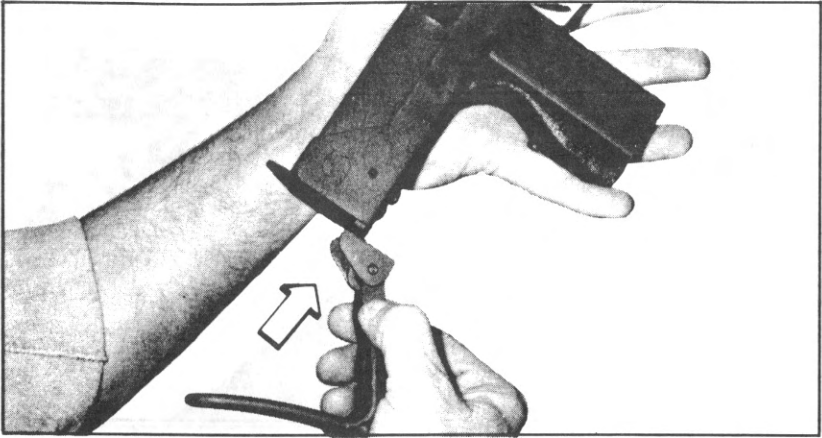

FIG. 7 Rotate Butt Stock To Closed Position

C. Loading and Cocking the Weapon

Move frame safety lever to 'fire' position. Holding the gun by the pistol grip in the right hand and keeping the index finger outside the trigger guard pull back on the cocking handle to the rear with the left hand until the bolt is held to the rear by the sear. (See Fig. 8) Move safety lever to 'safe' position.

Insert loaded magazine in its housing until the magazine catch engages magazine. (See Fig. 9) Select 'semi' or 'auto' fire as required, move frame safety to 'fire' position.

The gun is now ready to fire.

D. Charging the Weapon



FIG. 8

E. Inserting the Magazine

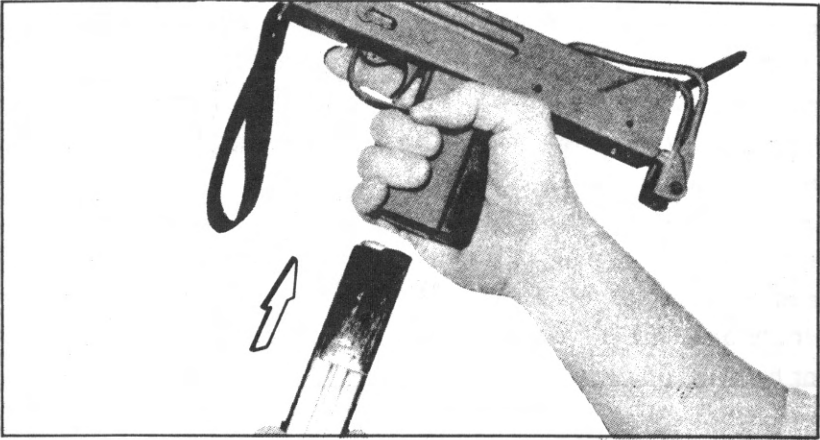

FIG. 9

F. Placing the Weapon on "Safe"

The safety is located on the right of the underside of the frame, it moves front to back, front is the 'fire' position and back is the 'safe' position. (See Fig. 10)

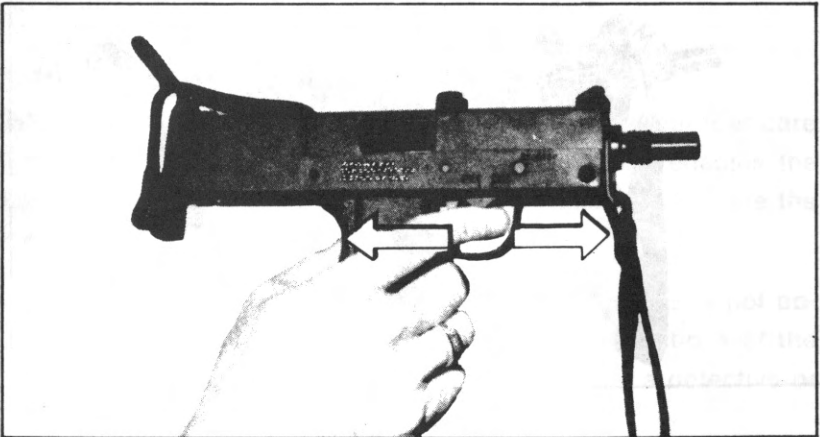

FIG. 10

G. Removal of Magazine

Grasp magazine in left hand and with left thumb press magazine catch to release magazine. (See Fig. 11)

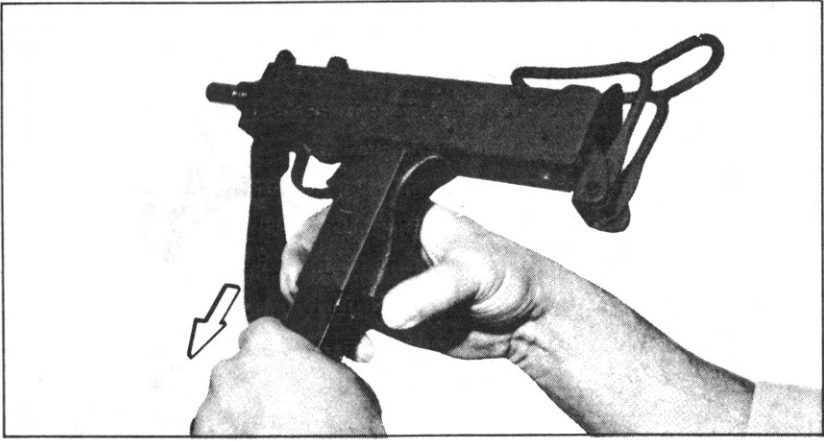

FIG. 11

H. Fire Selector Lever Operation

Located on the left side of the frame the selector is rotated to select 'semi' automatic or 'full' automatic fire. (See Fig. 12)

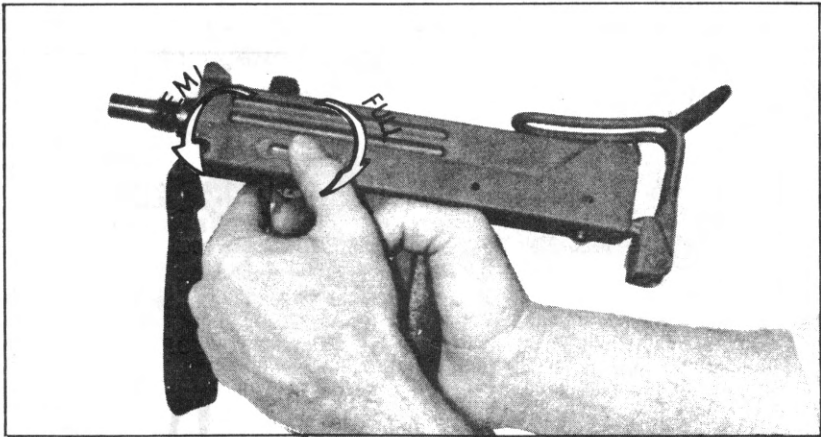

FIG. 12

I. Firing the Submachine Gun

As the bolt is moved back to the cocked position, the recoil spring is compressed and the sear engages the sear notch of the bolt. When the trigger is pressed, the sear releases the bolt, which is driven forward by the recoil spring. During this forward movement, the bolt strips a cartridge from the magazine into the chamber. The bolt continues forward and fires the cartridge. When the cartridge is fired, the chamber pressure forces the bullet out of the muzzle of the barrel. At the same time, this pressure overcomes the forward movement of the bolt and starts it to the rear. By the time the bolt and empty case have moved to the rear far enough to open the rear of the chamber, the bullet has left the barrel, and the chamber pressure has diminished. (In the submachine gun, the chamber pressure is relatively low and the bolt is relatively heavy; this eliminates the need for positive locking and unlocking.) During the rearward movement of the bolt, the empty cartridge case is extracted and ejected, the recoil spring is compressed and the top round in the magazine moves up against the lips of the magazine. The rearward movement of the bolt is stopped by contact with the buffer plate.

J. Malfunctions

Malfunctions are usually the result of worn parts or improper care of the gun. A knowledge of how the gun functions enables the user to classify and correct the malfunction. Listed below are the types of malfunctions which might occur.

1. **Failure to Feed.** The top cartridge in the magazine is not positioned up and in front of the bolt. Most malfunctions of the submachine gun are failures to feed caused by a defective or dirty magazine.
2. **Failure to Chamber.** The top cartridge from the magazine is not seated in the chamber.
3. **Failure to Fire.** The cartridge is chambered but does not fire.

4. **Failure to Extract.** If the cartridge fires, the chamber pressure will normally push the empty cartridge case out of the chamber. If the cartridge case is not completely removed from the chamber and the bolt is retracted, then there is a failure to extract. This malfunction seldom occurs.
5. **Failure to Eject.** The empty cartridge case is not ejected from the weapon.
6. **Failure to Cock.** If the bolt is retracted and is not held by the sear, or if, during firing, the bolt does not move to the rear far enough to clear the top cartridge in the magazine, the gun fails to cock.

Common Malfunctions. The two most common malfunctions are:

1. **Failure to feed**—usually caused by a defective magazine.
2. **Failure to fire**—usually caused by defective ammunition.

Causes of Malfunctions. The following chart lists common causes of various malfunctions and corrective action.

Malfunctions	Cause	Corrective Action
Failure to feed.	Dirty or dented magazine.	Replace magazine.
	Weak or broken magazine spring.	Replace magazine.
	Worn magazine notch.	Replace magazine.
	Corroded ammunition.	Replace ammunition.
	Worn or broken magazine catch.	Replace magazine catch.
Failure to chamber.	Dirty chamber	Clean chamber.
	Obstruction in chamber.	Remove obstruction.
	Weak recoil springs.	Replace recoil spring.
Failure to fire.	Defective ammunition.	Replace ammunition.
	Defective firing pin.	Replace bolt.
	Weak recoil springs.	Replace recoil springs.
Failure to extract.	Broken extractor.	Replace extractor.

Failure to eject.	Broken ejector.	Replace ejector.
	Broken or missing extractor.	Replace extractor
Failure to cock.	Worn sear.	Replace sear.
	Worn sear notch.	Replace bolt.
	Bent guide rods.	Straighten.
	Low powered ammunition	Replace ammunition

Prevention of Malfunctions. Periodic inspection and proper care and cleaning will reduce the possibility of the submachine gun malfunctioning.

4. STRIPPING AND REASSEMBLING

The M-11/9mm has been designed so that no special tools are necessary in order to strip or reassemble the weapon.

Stripping

Before starting to strip the weapon remove the magazine and check the barrel chamber by looking through the EJECTION PORT to make sure there are no live rounds in the weapon.

A. Field Stripping consists of

1) Removing Upper Receiver (Cock Weapon)

Depress and disengage receiver pin lock and remove from receiver pin. The receiver pin may now be removed. (See Fig. 13). On alternate configuration where there is no receiver pin catch, a sharp push on the receiver pin is all that is required for removal.

Push upper receiver from frame. (See Fig. 14)

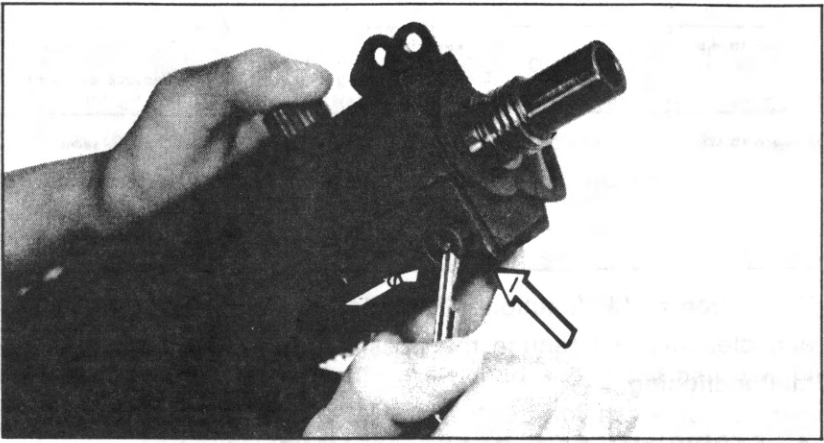

FIG. 13 Removing Pin Securing Receiver Group

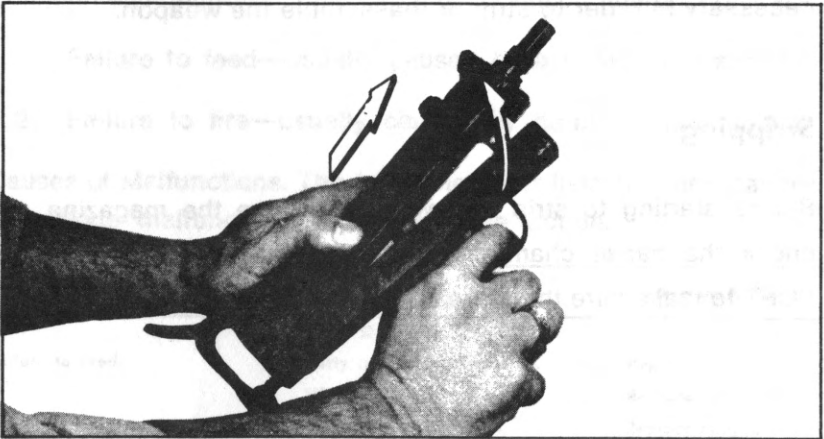

FIG. 14 Removing Barrel and Receiver Group

2) Removing the Bolt

Slide cocking handle to rear of guide slot, rotate handle a few degrees and pull from bolt. (See Fig. 15) The bolt and recoil spring assembly can now be removed from the rear of the receiver. (See Fig. 16)

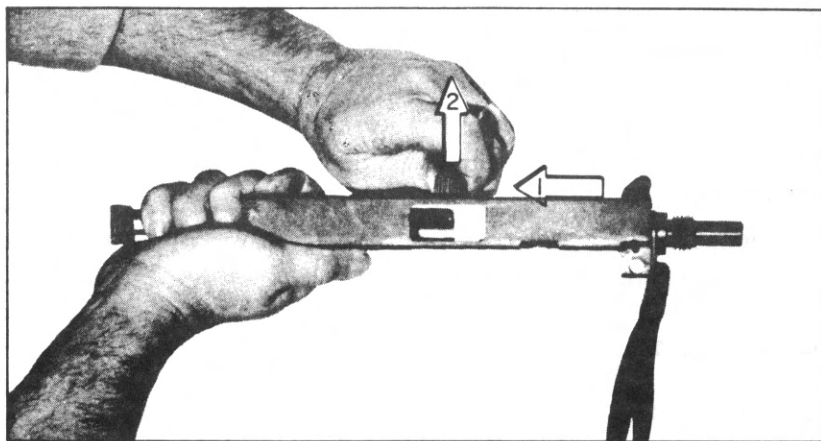

FIG. 15 Removing Cocking Handle

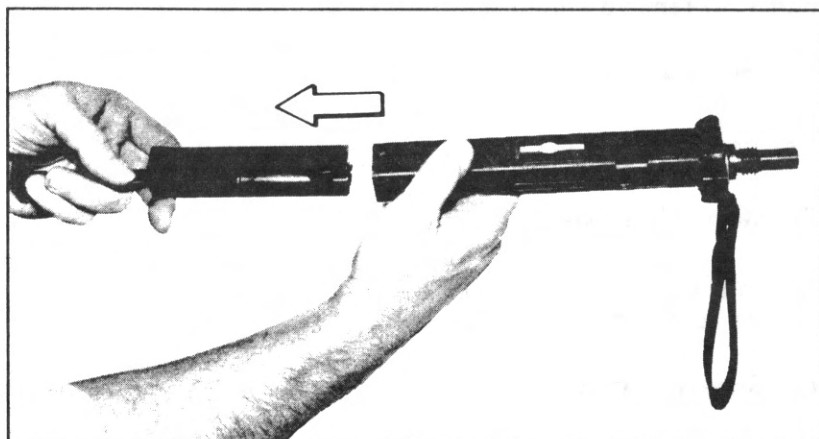

FIG. 16 Bolt Remover from Rear of Receiver

3) Removing the Stock

To remove stock, depress stock latch button and keeping pressure on button pull completely out. (See Figs. 5 and 6)

The procedure mentioned above is generally sufficient for normal maintenance and cleaning. If necessary to clean trigger mechanism, removal is as follows:

B. Trigger Mechanism

Lift retainer and remove selector lever, this also allows removal of sear, sear spring and tripping lever. Push trigger pin out of the left side for removal of trigger or torsion spring. Note: for re-assembly, free arm of torsion spring is located on rear side of disconnecter. Disconnecter may be replaced by using a pin punch to remove spring pin.

C. Extractor

Use pin punch to remove extractor spring pin.

D. Recoil Spring

Compress spring and move guide rod clear of bolt and use pin punch to remove spring pin from guide rod.

E. Receiver Pin

Use car key or similar object to remove receiver pin lock.

F. Magazine Catch

Use flat bladed screw-driver to remove screw in hand grip for access to catch.

G. Safety Catch

Use pin punch to remove catch spring pin.

H. Stock Latch

Press down lightly at center of pin and slide to either side to remove retaining pin. Invert frame and latch will drop out.

I. Magazine

M-11/9mm Para

Depress stud in floor plate and slide plate from magazine case. Keeping finger over the bottom of the magazine to prevent the magazine spring from flying out. Remove the magazine spring and the magazine follower.

N O T E : To achieve the proper functioning when reassembling the M-11/9mm magazine ensure that the slope of the top coil of the spring corresponds with the slope on the follower.

5. REASSEMBLY

Items are reassembled in the reverse order to the stripping procedure.

6. CLEANING AND MAINTENANCE

It is essential for reliable operation and performance that the weapon receive careful maintenance. It should be cleaned at the end of each day's firing.

The Gun need only be "field stripped" for this maintenance.

Barrel and Receiver Group Cleaning

- A. Use cleaning rod, patch and solvent. Stubborn residue can be removed with a bristle bore brush.
- B. Swab bore with patch saturated in solvent.
- C. Use solvent saturated patch and swab inside of receiver to remove residue.
- D. Use clean dry patch to dry barrel and inside of receiver group.
- E. Dampen patch with light oil and swab barrel and receiver.

Bolt Assembly Cleaning

- A. Remove powder residue with solvent and patch.
- B. Wipe all surfaces of bolt to remove carbon. The bolt face should be completely free of carbon and other residue.
- C. Wipe dry and apply a light coat of oil.

Frame Assembly Group Cleaning

- A. Remove residue build-up on exposed surfaces with solvent-soaked cloth.
- B. Clean around the lockwork. The weapon is designed to tolerate some dirt in the frame group but excessive dirt will impair operation. Detail cleaning is required after prolonged operation or improper functioning of weapon.
- C. Wipe dry and use oily patch to coat exposed metal areas with light film of oil.

Magazine Cleaning

- A. Inspect magazine for damaged areas. Damaged magazines should be discarded.
- B. Clean lip area and top of the follower.
- C. Wipe with clean patch.

Suppressor Cleaning

The suppressor requires no other maintenance apart from ensuring that the bore is kept clear of obstructions. Inspection must be made with the suppressor removed from the weapon. The front end cap of the suppressor has replaceable urethane discs which should be replaced every 500 rounds or sooner if the noise level increases significantly.

This illustrated parts breakdown is basically the same for all M-10, M-11, and M-11/9mm submachine guns. This includes all pre 1983 M.A.C. and R.P.B. guns, and the current S.W.D. Inc. guns. Please order by part no., description, caliber, and model.

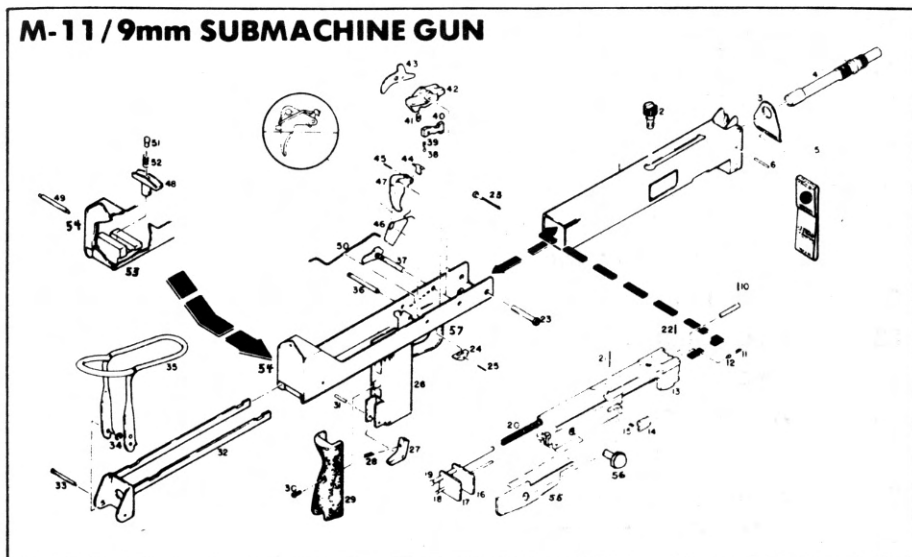

ILLUSTRATED PARTS LIST

Item	Title
1.	Receiver
2.	Bolt Handle
3.	Hanger
4.	Barrel —Factory Installed (send upper receiver.)
5.	Strap Assembly
6.	Spring Pin, Barrel
10.	Spring Pin, Recoil Spring Rod - Obsolete on Current Production
11.	Compression Spring, Bolt Handle Detent - Obsolete on Current Production
12.	Bolt Handle Detent - Obsolete on Current Production
13.	Bolt
14.	Extractor
15.	Compression Spring, Extractor
16.	Buffer
17.	Plate
18.	Ejector
19.	Guide Rod
20.	Compression Spring, Recoil
21.	Spring Pin, Extractor

22. Spring Pin, Bolt Handle Detent - Obsolete on Current Production
23. Receiver Pin
24. Button
25. Spring Pin Safety
26. Magazine Housing
27. Magazine Catch
28. Compression Spring—Magazine Catch
29. Grip
30. Grip Screw
31. Magazine Catch Pin
32. Stock Rail
33. Stock Hinge Pin
34. Retaining Ring
35. Wire Form Butt
36. Trigger Pin
37. Sear Pin
38. Safety Detent Plunger
39. Compression Spring, Safety Detent
40. Safety Slide
41. Compression Spring, Sear
42. Sear
43. Trip
44. Disconnecter
45. Spring Pin, Disconnecter
46. Torsion Spring, Trigger
47. Trigger
48. Latch
49. Stock Latch Pin
50. Retainer
51. Plunger, Stock Latch
52. Compression Spring, Stock Latch
53. Stock Block
54. Rear Sight Plate
55. Firing Pin
56. Firing Pin Retainer
57. Trigger Guard

M-11/9mm SUPPRESSOR BREAKDOWN

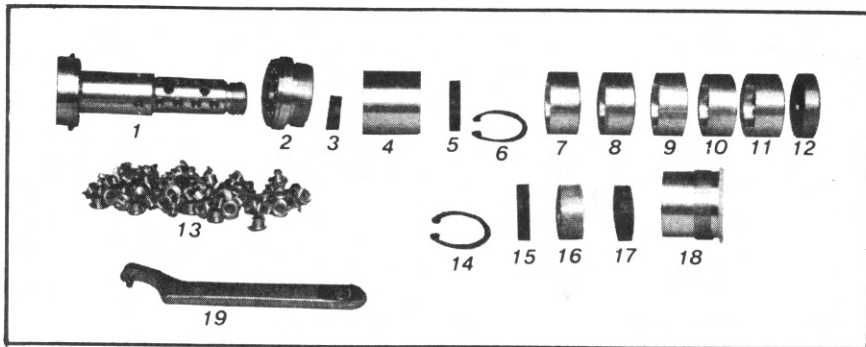

- | | |
|-------------------------------------|-------------------------|
| 1. sleeve | 12. encapsulator |
| 2. bushing | 13. rear baffle assy. |
| 3. rear wipe disc | 14. lock ring |
| 4. rear wipe chamber | 15. wipe disc |
| 5. middle wipe disc | 16. spacer |
| 6. lock ring | 17. wipe disc |
| 7., 8., 9., 10., 11., front baffles | 18. end cap |
| | 19. assy./disassy. tool |

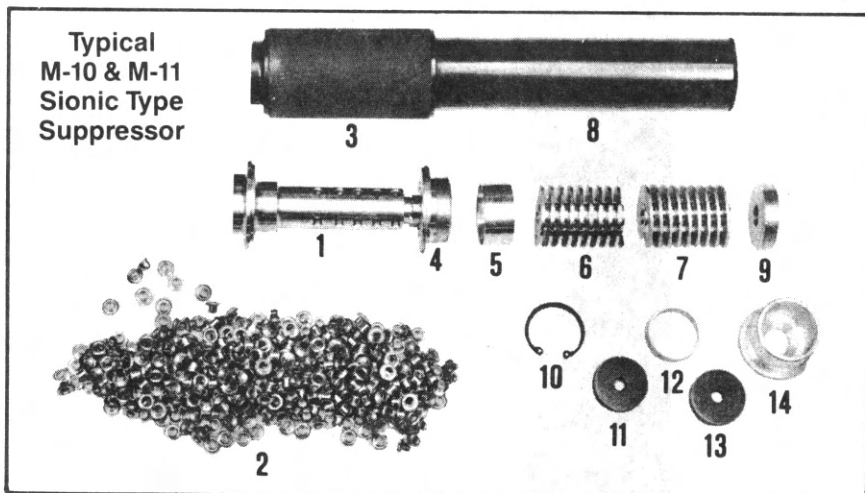

- | | |
|----------------------|-----------------|
| 1. sleeve | 8. tube |
| 2. rear baffle assy. | 9. encapsulator |
| 3. tube | 10. lock ring |
| 4. bushing | 11. disc |
| 5. baffle | 12. spacer |
| 6. spiral | 13. disc |
| 7. spiral | 14. end cap |

M-11/9mm MAGAZINE BREAKDOWN

Magazine Follower

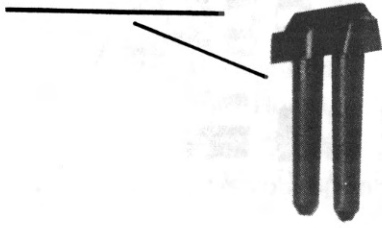

Magazine Body

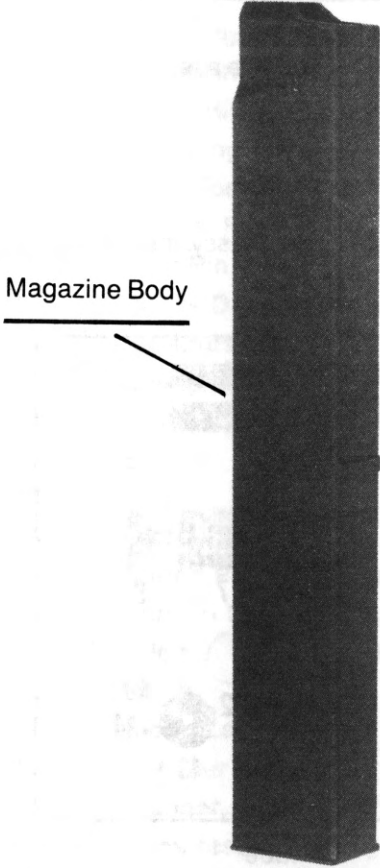

Magazine Floor Plate

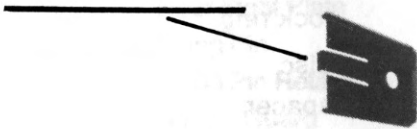

Magazine Spring



COBRAY[™]

ARMS AND ACCESSORIES